

20MHz, High Slew Rate, Uncompensated, High Input Impedance, Operational Amplifiers

HA-2520/2522/2525 comprise a series of operational amplifiers delivering an unsurpassed combination of specifications for slew rate, bandwidth and settling time. These dielectrically isolated amplifiers are controlled at close loop gains greater than 3 without external compensation. In addition, these high performance components also provide low offset current and high input impedance.

120V/ μ s slew rate and 200ns (0.2%) settling time of these amplifiers make them ideal components for pulse amplification and data acquisition designs. These devices are valuable components for RF and video circuitry requiring up to 20MHz gain bandwidth and 2MHz power bandwidth. For accurate signal conditioning designs the HA-2520/2522/2525's superior dynamic specifications are complemented by 10nA offset current, 100M Ω input impedance and offset trim capability. MIL-STD-883 product and data sheets are available upon request.

Ordering Information

PART NUMBER (BRAND)	TEMP. RANGE (°C)	PACKAGE	PKG. NO.
HA2-2520-2	-55 to 125	8 Pin Metal Can	T8.C
HA2-2522-2	-55 to 125	8 Pin Metal Can	T8.C
HA2-2525-5	0 to 75	8 Pin Metal Can	T8.C
HA3-2525-5	0 to 75	8 Ld PDIP	E8.3
HA7-2520-2	-55 to 125	8 Ld CERDIP	F8.3A
HA7-2525-5	0 to 75	8 Ld CERDIP	F8.3A
HA9P2525-5 (H25255)	0 to 75	8 Ld SOIC	M8.15

Features

- High Slew Rate 120V/ μ s
- Fast Settling 200ns
- Full Power Bandwidth 2MHz
- Gain Bandwidth ($A_V \geq 3$) 20MHz
- High Input Impedance 100M Ω
- Low Offset Current 10nA
- Compensation Pin for Unity Gain Capability

Applications

- Data Acquisition Systems
- RF Amplifiers
- Video Amplifiers
- Signal Generators

Pinouts

HA-2520 (CERDIP)
HA-2525 (PDIP, CERDIP, SOIC)
TOP VIEW

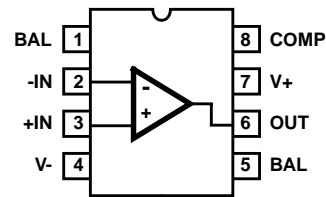

HA-2520/22/25
(METAL CAN)
TOP VIEW

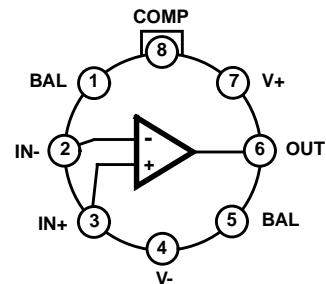

HA-2520, HA-2522, HA-2525

Absolute Maximum Ratings

Supply Voltage (Between V+ and V- Terminals)	40V
Differential Input Voltage	15V
Output Current	50mA

Operating Conditions

Temperature Range	
HA-2520/2522-2	-55°C to 125°C
HA-2525-5	0°C to 75°C

Thermal Information

Thermal Resistance (Typical, Note 1)	θ_{JA} (°C/W)	θ_{JC} (°C/W)
Metal Can Package	165	80
PDIP Package	96	N/A
CERDIP Package	135	50
SOIC Package	157	N/A
Maximum Junction Temperature (Hermetic Packages)	175°C	
Maximum Junction Temperature (Plastic Package)	150°C	
Maximum Storage Temperature Range	-65°C to 150°C	
Maximum Lead Temperature (Soldering 10s)	300°C (SOIC - Lead Tips Only)	

CAUTION: Stresses above those listed in "Absolute Maximum Ratings" may cause permanent damage to the device. This is a stress only rating and operation of the device at these or any other conditions above those indicated in the operational sections of this specification is not implied.

NOTE:

- θ_{JA} is measured with the component mounted on an evaluation PC board in free air.

Electrical Specifications $V_{SUPPLY} = \pm 15V$

PARAMETER	TEMP (°C)	HA-2520-2			HA-2522-2			HA-2525-5			UNITS
		MIN	TYP	MAX	MIN	TYP	MAX	MIN	TYP	MAX	
INPUT CHARACTERISTICS											
Offset Voltage	25	-	4	8	-	5	10	-	5	10	mV
	Full	-	-	11	-	-	14	-	-	14	mV
Offset Voltage Drift	Full	-	20	-	-	25	-	-	30	-	$\mu V/^\circ C$
Bias Current	25	-	100	200	-	125	250	-	125	250	nA
	Full	-	-	400	-	-	500	-	-	500	nA
Offset Current	25	-	10	25	-	20	50	-	20	50	nA
	Full	-	-	50	-	-	100	-	-	100	nA
Input Resistance (Note 2)	25	50	100	-	40	100	-	40	100	-	M Ω
Common Mode Range	Full	± 10.0	-	-	± 10.0	-	-	± 10.0	-	-	V
TRANSFER CHARACTERISTICS											
Large Signal Voltage Gain (Notes 3, 6)	25	10	15	-	7.5	15	-	7.5	15	-	kV/V
	Full	7.5	-	-	5	-	--	5	-	-	kV/V
Common Mode Rejection Ratio (Note 4)	Full	80	90	-	74	90	-	74	90	-	dB
Gain Bandwidth (Notes 2, 5)	25	10	20	-	10	20	-	10	20	-	MHz
Minimum Stable Gain	25	3	-	-	3	-	-	3	-	-	V/V
OUTPUT CHARACTERISTICS											
Output Voltage Swing (Note 3)	Full	± 10.0	± 12.0	-	± 10.0	± 12.0	-	± 10.0	± 12.0	-	V
Output Current (Note 6)	25	± 10	± 20	-	± 10	± 20	-	± 10	± 20	-	mA
Full Power Bandwidth (Notes 6, 11)	25	1.5	2.0	-	1.2	2.0	-	1.2	2.0	-	MHz
TRANSIENT RESPONSE ($A_V = +3$)											
Rise Time (Notes 3, 7, 8, 10)	25	-	25	50	-	25	50	-	25	50	ns
Overshoot (Notes 3, 7, 8, 10)	25	-	25	40	-	25	50	-	25	50	%
Slew Rate (Notes 3, 7, 10, 12)	25	± 100	± 120	-	± 80	± 120	-	± 80	± 120	-	V/ μs
Settling Time (Notes 3, 7, 10, 12)	25	-	0.20	-	-	0.20	-	-	0.20	-	μs

Electrical Specifications $V_{SUPPLY} = \pm 15V$ (Continued)

PARAMETER	TEMP (°C)	HA-2520-2			HA-2522-2			HA-2525-5			UNITS
		MIN	TYP	MAX	MIN	TYP	MAX	MIN	TYP	MAX	
POWER SUPPLY CHARACTERISTICS											
Supply Current	25	-	4	6	-	4	6	-	4	6	mA
Power Supply Rejection Ratio (Note 9)	Full	80	90	-	74	90	-	74	90	-	dB

NOTES:

2. This parameter value is based on design calculations.
3. $R_L = 2k\Omega$.
4. $V_{CM} = \pm 10V$.
5. $A_V > 10$.
6. $V_O = \pm 10.0V$.
7. $C_L = 50pF$.
8. $V_O = \pm 200mV$.
9. $\Delta V = \pm 5.0V$.
10. See Transient Response Test Circuits and Waveforms.
11. Full Power Bandwidth guaranteed based on slew rate measurement using: $FPBW = \frac{Slew\ Rate}{2\pi V_{PEAK}}$.
12. $V_{OUT} = \pm 5V$.

Test Circuits and Waveforms

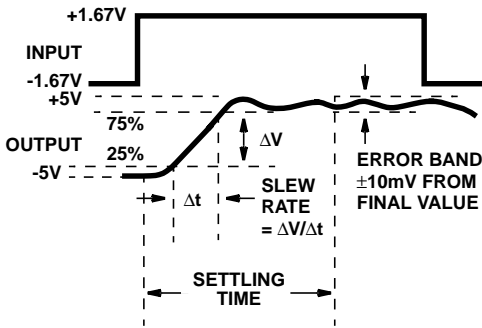
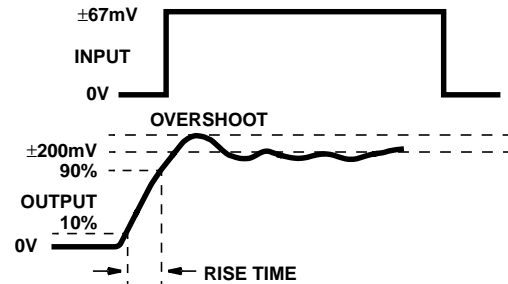

FIGURE 1. SLEW RATE AND SETTLING TIME



NOTE: Measured on both positive and negative transitions from 0V to +200mV and 0V to -200mV at the output.

FIGURE 2. TRANSIENT RESPONSE

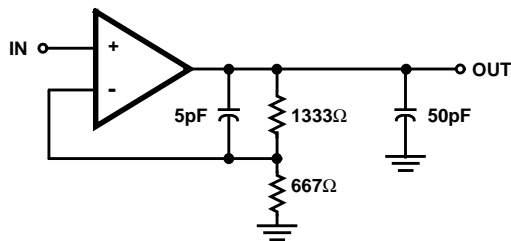
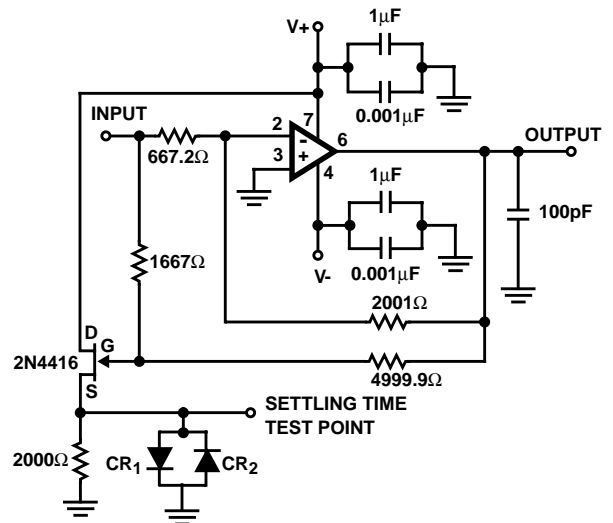

FIGURE 3. SLEW RATE AND TRANSIENT RESPONSE



NOTES:

13. $A_V = -3$.
14. Feedback and summing resistor ratios should be 0.1% matched.
15. Clipping diodes CR₁ and CR₂ are optional. HP5082-2810 recommended.

FIGURE 4. SETTLING TIME TEST CIRCUIT

Test Circuits and Waveforms (Continued)

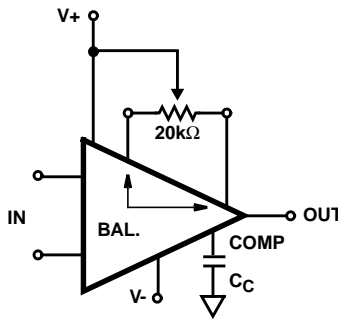

NOTE: Tested offset adjustment range is $|V_{OS} + 1mV|$ minimum referred to output. Typical ranges are $\pm 20mV$ with $R_T = 20k\Omega$.

FIGURE 5. SUGGESTED V_{OS} ADJUSTMENT AND COMPENSATION HOOK-UP

Schematic Diagram

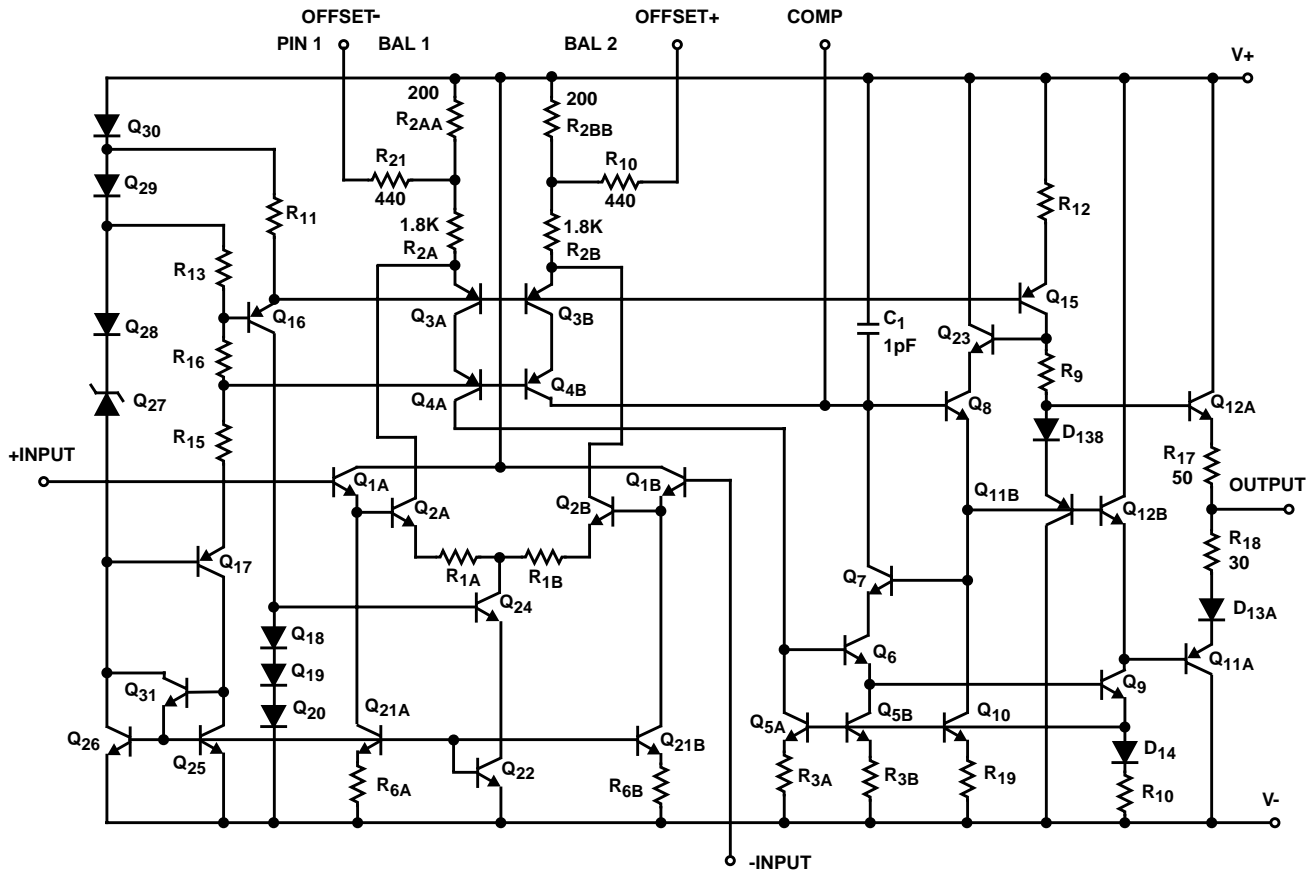

All Intersil semiconductor products are manufactured, assembled and tested under ISO9000 quality systems certification.

Intersil semiconductor products are sold by description only. Intersil Corporation reserves the right to make changes in circuit design and/or specifications at any time without notice. Accordingly, the reader is cautioned to verify that data sheets are current before placing orders. Information furnished by Intersil is believed to be accurate and reliable. However, no responsibility is assumed by Intersil or its subsidiaries for its use; nor for any infringements of patents or other rights of third parties which may result from its use. No license is granted by implication or otherwise under any patent or patent rights of Intersil or its subsidiaries.

For information regarding Intersil Corporation and its products, see web site <http://www.intersil.com>

Typical Application

Inverting Unity Gain Circuit

Figure 6 shows a Compensation Circuit for an inverting unity gain amplifier. The circuit was tested for functionality with supply voltages from $\pm 4V$ to $\pm 15V$, and the performance as tested was: Slew Rate $\approx 120V/\mu s$; Bandwidth $\approx 10MHz$; and Settling Time (0.1%) $\approx 500ns$. Figure 7 illustrates the amplifier's frequency response, and it is important to note that capacitance at pin 8 must be minimized for maximum bandwidth.

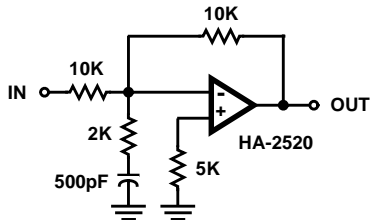

FIGURE 6. INVERTING UNITY GAIN CIRCUIT

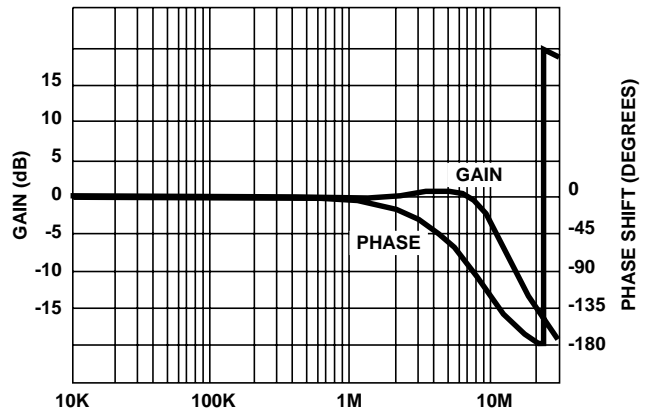

FIGURE 7. FREQUENCY RESPONSE FOR INVERTING UNITY GAIN CIRCUIT

Typical Performance Curves $V_S = \pm 15V, T_A = 25^\circ C$, Unless Otherwise Specified

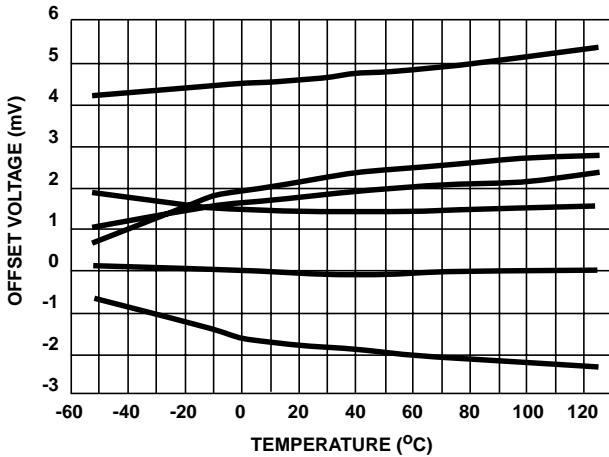

FIGURE 8. OFFSET VOLTAGE vs TEMPERATURE (6 TYPICAL UNITS FROM 3 LOTS)

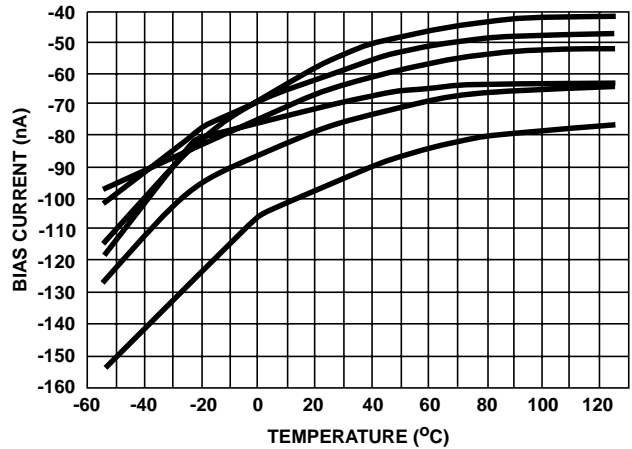

FIGURE 9. BIAS CURRENT vs TEMPERATURE (6 TYPICAL UNITS FROM 3 LOTS)

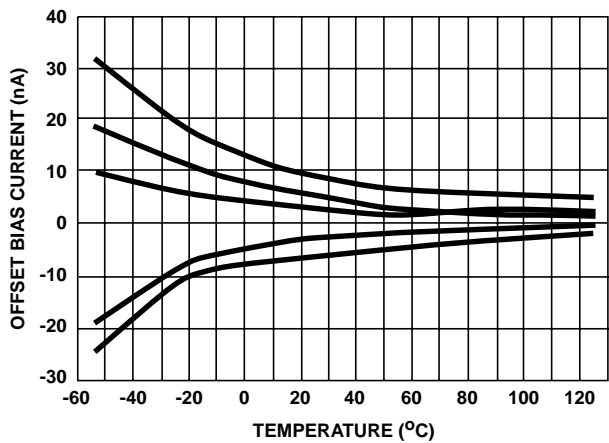

FIGURE 10. OFFSET CURRENT vs TEMPERATURE (5 TYPICAL UNITS FROM 3 LOTS)

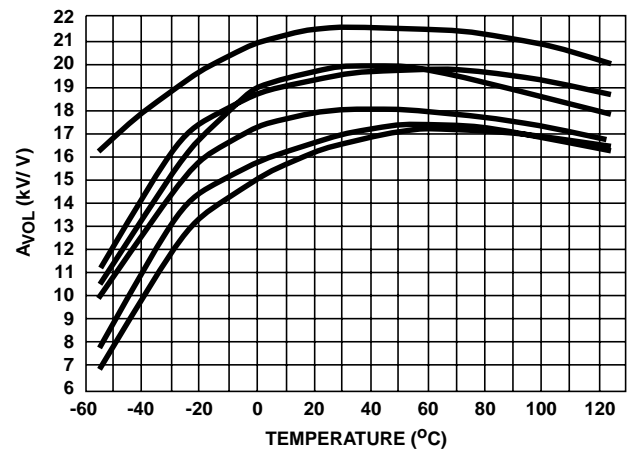

FIGURE 11. OPEN LOOP GAIN vs TEMPERATURE (6 TYPICAL UNITS FROM 3 LOTS)

Typical Performance Curves $V_S = \pm 15V$, $T_A = 25^\circ C$, Unless Otherwise Specified (Continued)

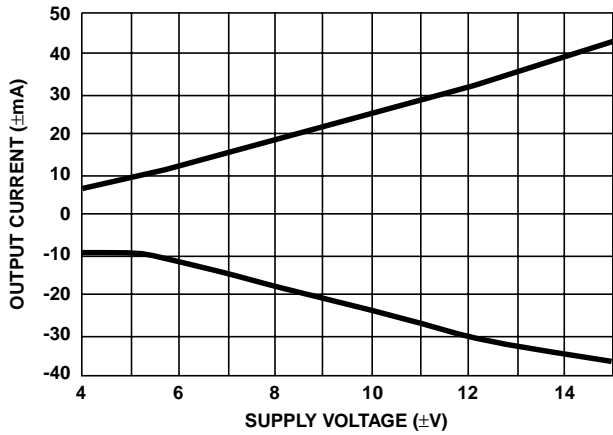

FIGURE 12. OUTPUT CURRENT vs SUPPLY VOLTAGE

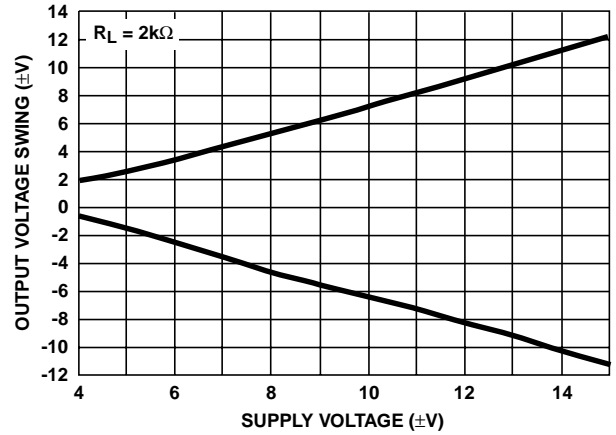

FIGURE 13. OUTPUT VOLTAGE SWING vs SUPPLY VOLTAGE

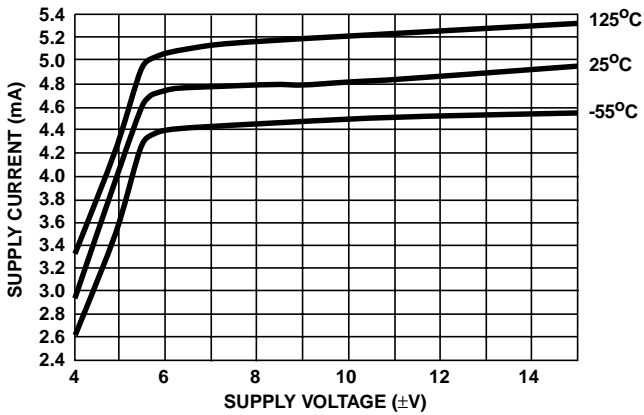

FIGURE 14. SUPPLY CURRENT vs SUPPLY VOLTAGE

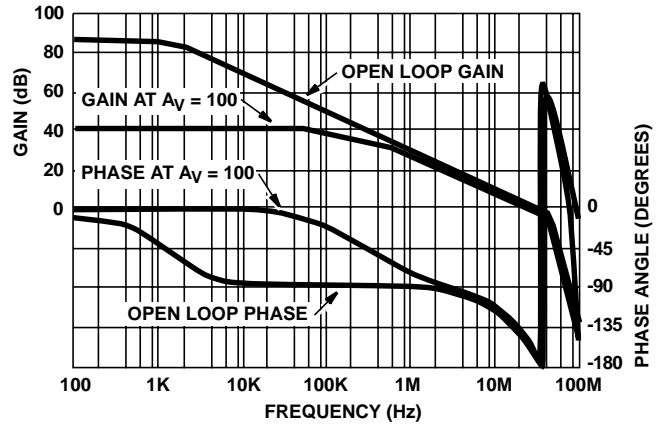

FIGURE 15. FREQUENCY RESPONSE

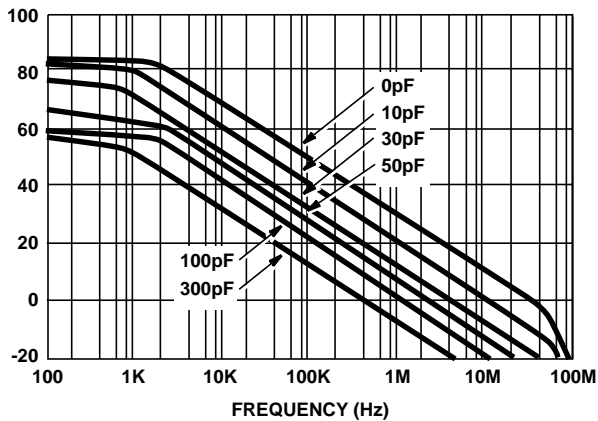

FIGURE 16. OPEN LOOP FREQUENCY RESPONSE FOR VARIOUS VALUES OF CAPACITORS FROM COMP PIN TO GROUND

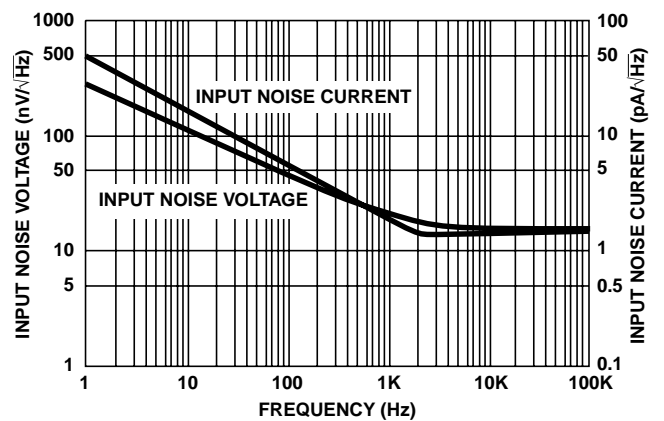

FIGURE 17. INPUT NOISE CHARACTERISTICS

Typical Performance Curves $V_S = \pm 15V, T_A = 25^\circ C$, Unless Otherwise Specified (Continued)

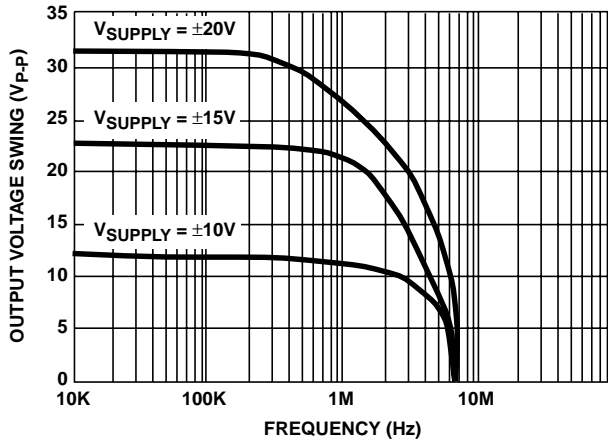

FIGURE 18. OUTPUT VOLTAGE SWING vs FREQUENCY

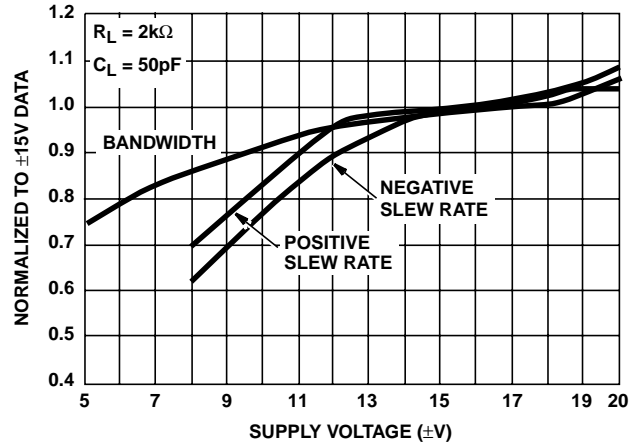

FIGURE 19. NORMALIZED AC PARAMETERS vs SUPPLY VOLTAGE

Die Characteristics

DIE DIMENSIONS:

67 mils x 57 mils x 19 mils
(1700 μ m x 1440 μ m x 483 μ m)

METALLIZATION:

Type: Al, 1% Cu
Thickness: 16k Å \pm 2k Å

SUBSTRATE POTENTIAL:

Unbiased

PASSIVATION:

Type: Nitride (Si_3N_4) over Silox (SiO_2 , 5% Phos.)
Silox Thickness: 12k Å \pm 2k Å
Nitride Thickness: 3.5k Å \pm 1.5k Å

TRANSISTOR COUNT:

40

PROCESS:

Bipolar Dielectric Isolation

Metallization Mask Layout

