

# General Purpose Transistor

## PNP Silicon

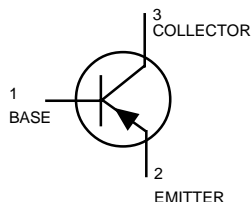

**MMBT2907LT1**  
**MMBT2907ALT1**

### MAXIMUM RATINGS

Rating	Symbol	Value		Unit
		2907	2907A	
Collector–Emitter Voltage	$V_{CE0}$	-40	-60	Vdc
Collector–Base Voltage	$V_{CBO}$		-60	Vdc
Emitter–Base Voltage	$V_{EBO}$		-5.0	Vdc
Collector Current — Continuous	$I_C$		-600	mAdc

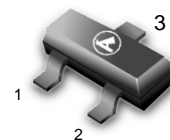

CASE 318-08, STYLE 6  
SOT-23 (TO-236AB)

### THERMAL CHARACTERISTICS

Characteristic	Symbol	Max	Unit
Total Device Dissipation FR-5 Board, (1) $T_A = 25^\circ\text{C}$	$P_D$	225	mW
Derate above $25^\circ\text{C}$		1.8	mW/ $^\circ\text{C}$
Thermal Resistance, Junction to Ambient	$R_{\theta JA}$	556	$^\circ\text{C}/\text{W}$
Total Device Dissipation Alumina Substrate, (2) $T_A = 25^\circ\text{C}$	$P_D$	300	mW
Derate above $25^\circ\text{C}$		2.4	mW/ $^\circ\text{C}$
Thermal Resistance, Junction to Ambient	$R_{\theta JA}$	417	$^\circ\text{C}/\text{W}$
Junction and Storage Temperature	$T_J, T_{\text{sig}}$	-55 to +150	$^\circ\text{C}$

### DEVICE MARKING

MMBT2907LT1 = M2B, MMBT2907ALT1 = 2F

### ELECTRICAL CHARACTERISTICS ( $T_A = 25^\circ\text{C}$ unless otherwise noted.)

Characteristic	Symbol	Min	Max	Unit
----------------	--------	-----	-----	------

### OFF CHARACTERISTICS

Collector–Emitter Breakdown Voltage(3) ( $I_C = -10 \text{ mAdc}, I_E = 0$ )	$V_{(BR)CEO}$			Vdc
	MMBT2907	-40	—	
	MMBT2907A	-60	—	
Collector–Emitter Breakdown Voltage( $I_C = -10 \mu\text{Adc}, I_E = 0$ )	$V_{(BR)CBO}$	-60	—	Vdc
Emitter–Base Breakdown Voltage( $I_E = -10 \mu\text{Adc}, I_C = 0$ )	$V_{(BR)EBO}$	-5.0	—	Vdc
Collector Cutoff Current( $V_{CB} = -30\text{Vdc}, I_{BE(\text{off})} = -0.5\text{Vdc}$ )	$I_{CEX}$	—	-50	nAdc
Collector Cutoff Current ( $V_{CB} = -50\text{Vdc}, I_E = 0$ )	$I_{CBO}$			$\mu\text{Adc}$
	MMBT2907	—	-0.020	
	MMBT2907A	—	-0.010	
( $V_{CB} = -50\text{Vdc}, I_E = 0, T_A = 125^\circ\text{C}$ )	MMBT2907	—	-20	
	MMBT2907A	—	-10	
Base Current( $V_{CE} = -30\text{Vdc}, V_{EB(\text{off})} = -0.5\text{Vdc}$ )	$I_B$	—	-50	nAdc

1. FR-5 =  $1.0 \times 0.75 \times 0.062$  in.

2. Alumina =  $0.4 \times 0.3 \times 0.024$  in. 99.5% alumina.

3. Pulse Test: Pulse Width  $\leq 300 \mu\text{s}$ , Duty Cycle  $\leq 2.0\%$ .

**MMBT2907LT1 MMBT2907ALT1**

**ELECTRICAL CHARACTERISTICS** ( $T_A = 25^\circ\text{C}$  unless otherwise noted) (Continued)

Characteristic	Symbol	Min	Max	Unit
<b>ON CHARACTERISTICS</b>				
DC Current Gain ( $I_C = -0.1\text{mA}$ , $V_{CE} = -10\text{Vdc}$ )	$h_{FE}$	35	—	—
		MMBT2907	75	
( $I_C = -1.0\text{mA}$ , $V_{CE} = -10\text{Vdc}$ )		50	—	—
		MMBT2907A	100	
( $I_C = -10\text{mA}$ , $V_{CE} = -10\text{Vdc}$ )		75	—	—
		MMBT2907A	100	
( $I_C = -150\text{mA}$ , $V_{CE} = -10\text{Vdc}$ )(3)		—	—	—
		MMBT2907A	100	
( $I_C = -500\text{mA}$ , $V_{CE} = -10\text{Vdc}$ )(3)		30	—	—
		MMBT2907A	50	
Collector–Emitter Saturation Voltage(3) ( $I_C = -150\text{mA}$ , $I_B = -15\text{mA}$ ) ( $I_C = -500\text{mA}$ , $I_B = -50\text{mA}$ )	$V_{CE(sat)}$	—	-0.4	Vdc
		—	-1.6	
Base–Emitter Saturation Voltage(3) ( $I_C = -150\text{mA}$ , $I_B = -15\text{mA}$ ) ( $I_C = -500\text{mA}$ , $I_B = -50\text{mA}$ )	$V_{BE(sat)}$	—	-1.3	Vdc
		—	-2.6	

**SMALL-SIGNAL CHARACTERISTICS**

Current–Gain — Bandwidth Product(3),(4) ( $I_C = -50\text{mA}$ , $V_{CE} = -20\text{Vdc}$ , $f = 100\text{MHz}$ )	$f_T$	200	—	MHz
Output Capacitance ( $V_{CB} = -10\text{Vdc}$ , $I_E = 0$ , $f = 1.0\text{MHz}$ )	$C_{obo}$	—	8.0	pF
Input Capacitance ( $V_{EB} = -2.0\text{Vdc}$ , $I_C = 0$ , $f = 1.0\text{MHz}$ )	$C_{ibo}$	—	30	pF

**SWITCHING CHARACTERISTICS**

Turn–On Time Delay Time Rise Time	( $V_{CC} = -30\text{Vdc}$ , $I_C = -150\text{mA}$ , $I_{B1} = -15\text{mA}$ )	$t_{on}$ $t^d$ $t_r$	— — —	45 10 40	ns
Fall Time Storage Time Turn–Off Time	( $V_{CC} = -6.0\text{Vdc}$ , $I_C = -150\text{mA}$ , $I_{B1} = I_{B2} = 15\text{mA}$ )	$t_f$ $t_s$ $t_{off}$	— — —	30 80 100	ns

3. Pulse Test: Pulse Width  $\leq 300\ \mu\text{s}$ , Duty Cycle  $\leq 2.0\%$ .

4.  $f_T$  is defined as the frequency at which  $|h_{fe}|$  extrapolates to unity.

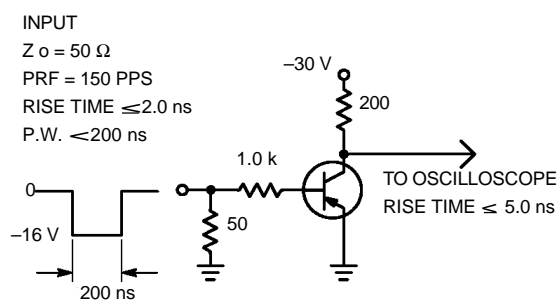

Figure 1. Delay and Rise Time Test Circuit

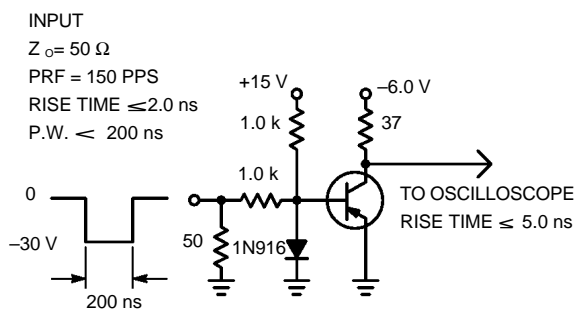

Figure 2. Storage and Fall Time Test Circuit

MMBT2907LT1 MMBT2907ALT1

TYPICAL CHARACTERISTICS

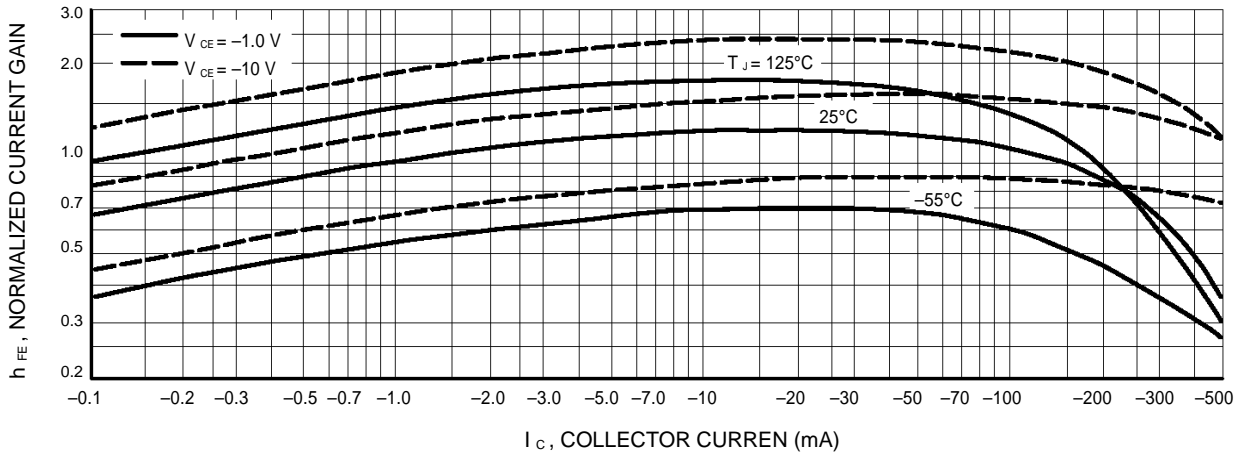

Figure 3. DC Current Gain

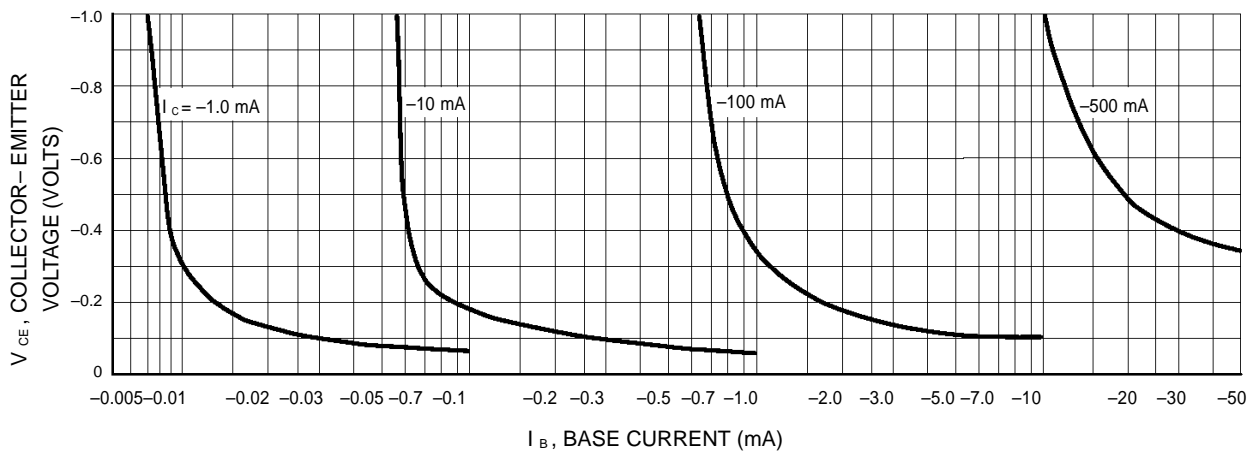

Figure 4. Collector Saturation Region

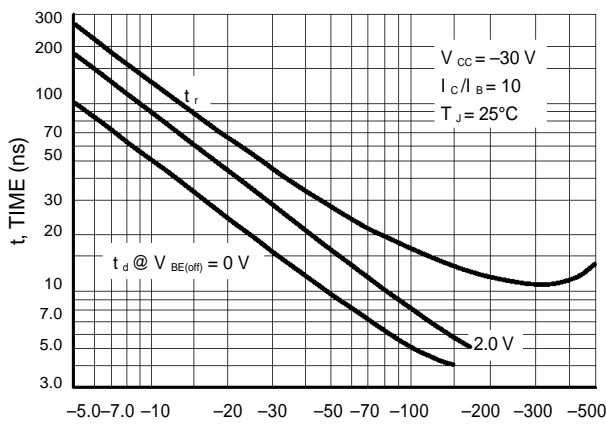

Figure 5. Turn-On Time

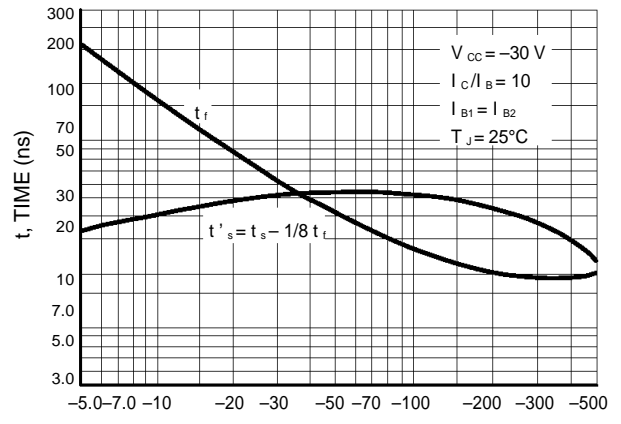

Figure 6. Turn-Off Time

MMBT2907LT1 MMBT2907ALT1

TYPICAL SMALL-SIGNAL CHARACTERISTICS

NOISE FIGURE

$V_{CE} = 10 \text{ Vdc}$ ,  $T_A = 25^\circ\text{C}$

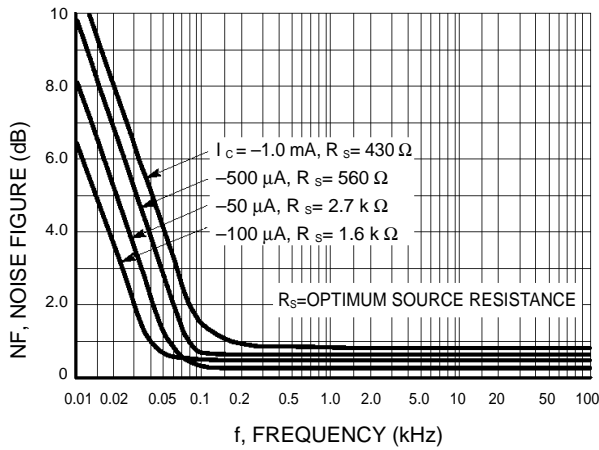

Figure 7. Frequency Effects

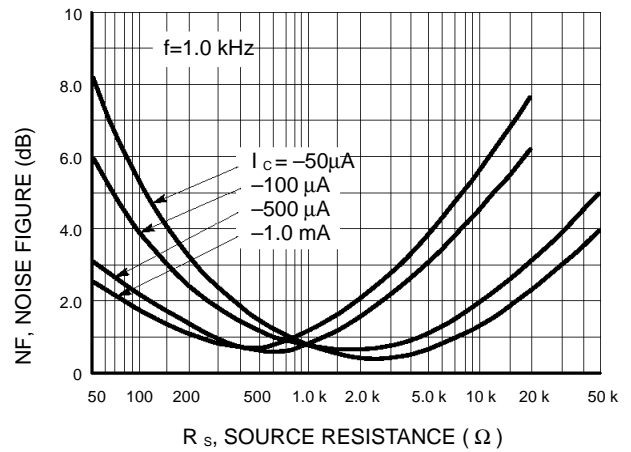

Figure 8. Source Resistance Effects

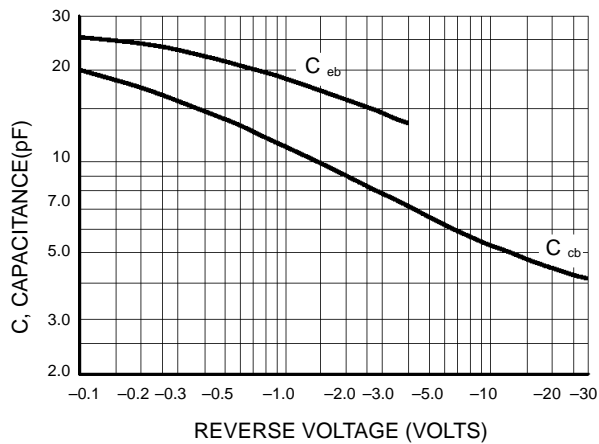

Figure 9. Capacitances

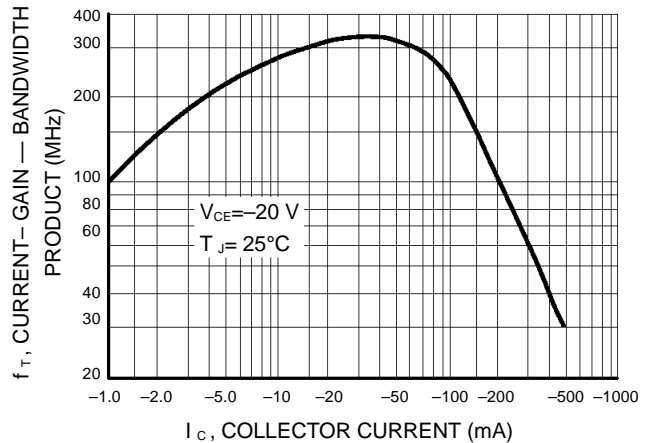

Figure 10. Current-Gain — Bandwidth Product

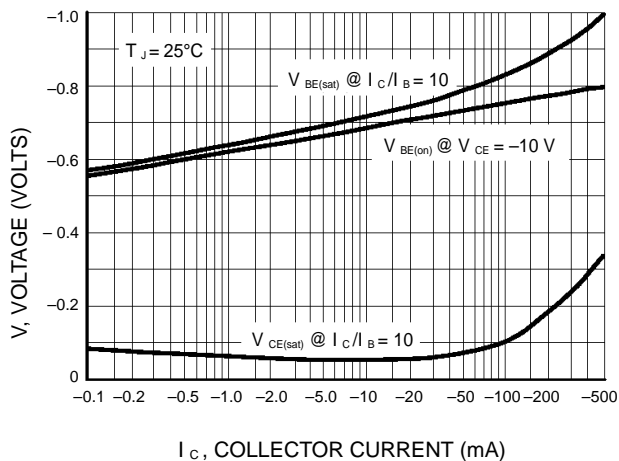

Figure 11. "On" Voltage

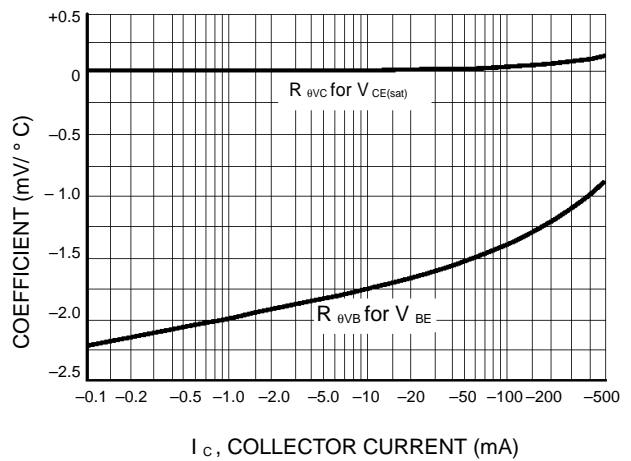

Figure 12. Temperature Coefficients