

2SA1343, 2SC3397



2018A

PNP/NPN Epitaxial Planar
Silicon Transistors

T-37-13
T-35-11

Switching Applications (with Bias Resistances R1=46kΩ, R2=23kΩ)

©1285C

Applications

- Switching circuit, inverter circuit, interface circuit, driver circuit.

Features

- Built-in bias resistor (R1=46kΩ, R2=23kΩ).
- Small-sized package (CP).

() : 2SA1343

Absolute Maximum Ratings/T_a=25°C

			unit
Collector to Base Voltage	V _{CB0}	(-)50	V
Collector to Emitter Voltage	V _{CEO}	(-)50	V
Emitter to Base Voltage	V _{EB0}	(-)10	V
Collector Current	I _C	(-)100	mA
Peak Collector Current	i _{cp}	(-)200	mA
Collector Dissipation	P _C	200	mW
Junction Temperature	T _j	150	°C
Storage Temperature	T _{stg}	-55 to +150	°C

Electrical Characteristics/T_a=25°C

			min	typ	max	unit
Collector Cutoff Current	I _{CB0}	V _{CB} =(-)40V, I _E =0			(-)0.1	μA
Collector Cutoff Current	I _{CEO}	V _{CE} =(-)40V, I _B =0			(-)0.5	μA
Emitter Cutoff Current	I _{EB0}	V _{EB} =(-)5V, I _C =0	(-)40	(-)72	(-)100	μA
DC Current Gain	h _{FE}	V _{CE} =(-)5V, I _C =(-)5mA	50			
Gain Band-width product	f _T	V _{CE} =(-)10V, I _C =(-)5mA		250 (200)		MHz
Output Capacitance	c _{ob}	V _{CB} =(-)10V, f=1MHz		3.5 (5.3)		pF
Collector to Emitter Saturation Voltage	V _{CE(sat)}	I _C =(-)5mA, I _B =(-)0.25mA	(-)0.1	(-)0.3		V

Continued on next page.

Marking

2SA1343: DL, 2SC3397: DY

Electrical Connection

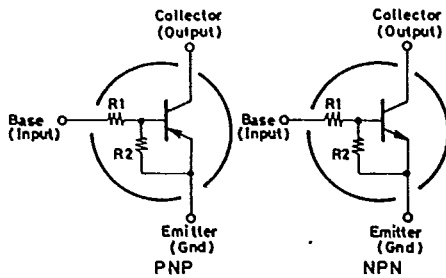

Case Outline 2018A (unit: mm)

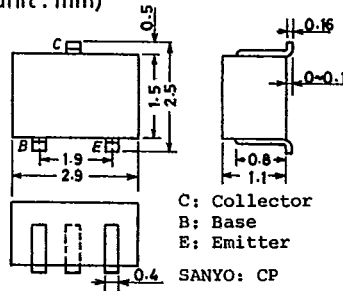

2SA1343/2SC3397

T-37-13
T-35-11

Continued from preceding page.

			min	typ	max	unit
Collector to Base Breakdown Voltage	$V_{(BR)CBO}$	$I_C=(-)10\mu A, I_E=0$	(-)50			V
Collector to Emitter Breakdown Voltage	$V_{(BR)CEO}$	$I_C=(-)100\mu A, R_{BE}=\infty$	(-)50			V
Input Off Voltage	$V_{I(off)}$	$V_{CE}=(-)5V, I_C=(-)100\mu A$	(-)1.2	(-)1.6	(-)2.3	V
Input On Voltage	$V_{I(on)}$	$V_{CE}=(-)0.2V, I_C=(-)5mA$	(-)1.5	(-)3.1	(-)6.0	V
Input Resistance	R1		32	46	60	k Ω
Input Resistance Ratio	R1/R2		1.8	2.0	2.2	-

■ Sample Application Circuit

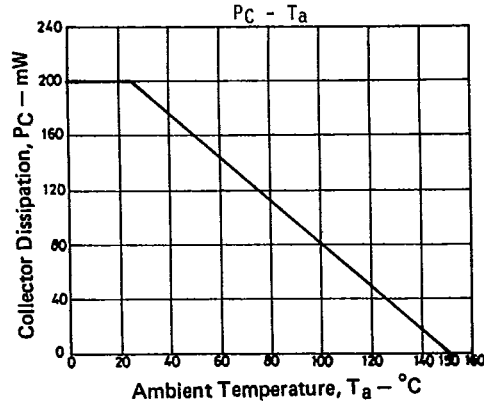
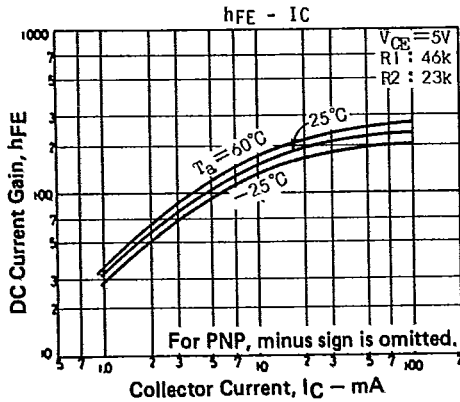
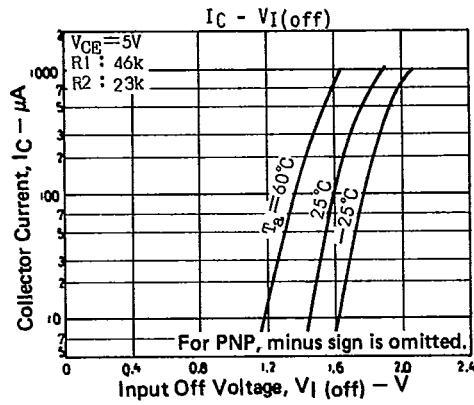
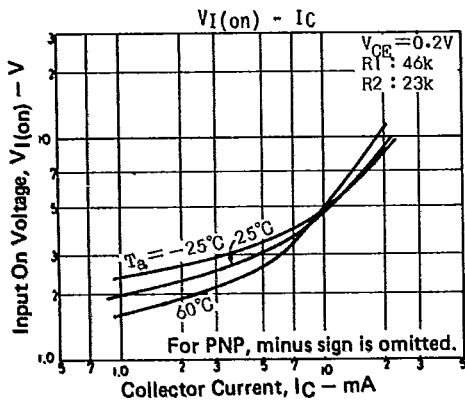
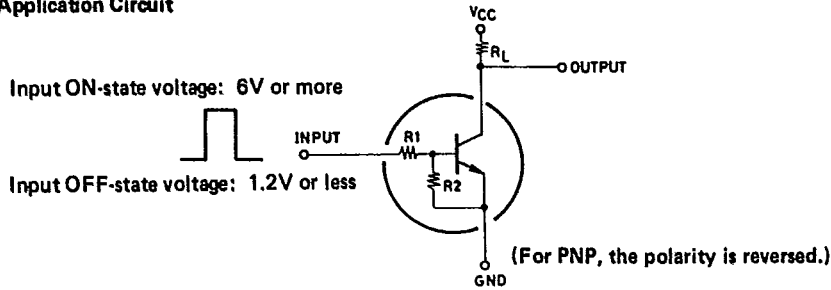

T-91-20

CASE OUTLINES OF SURFACE MOUNT TRANSISTORS

- All of Sanyo surface mount transistor case outlines are illustrated below.
- All dimensions are in mm, and dimensions which are not followed by min. or max. are represented by typical values.
- No marking is indicated.

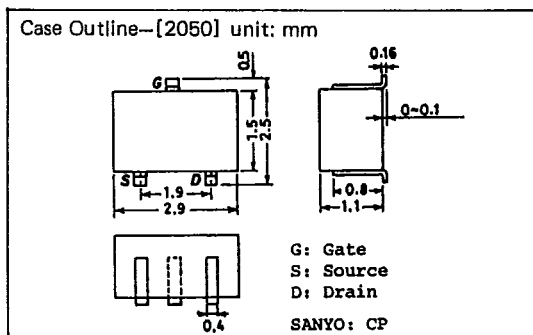
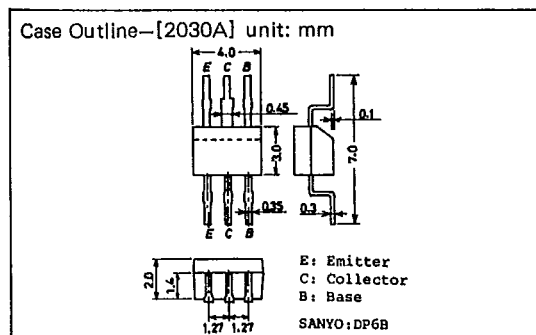
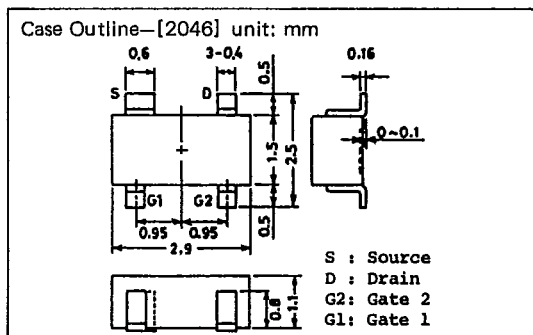
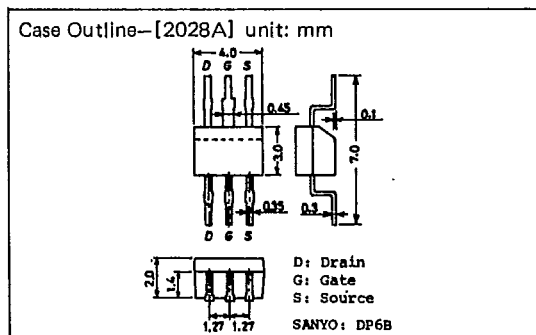
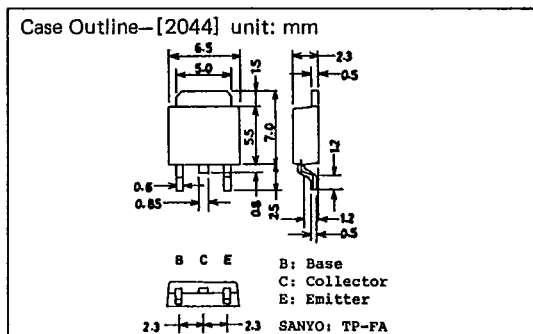
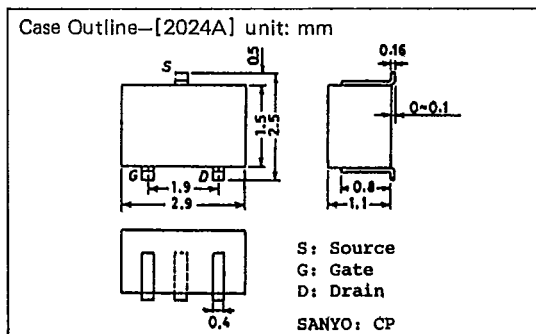
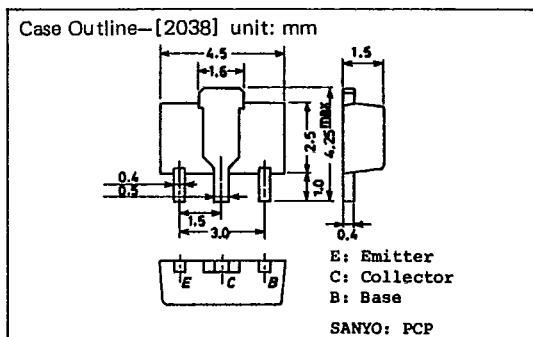
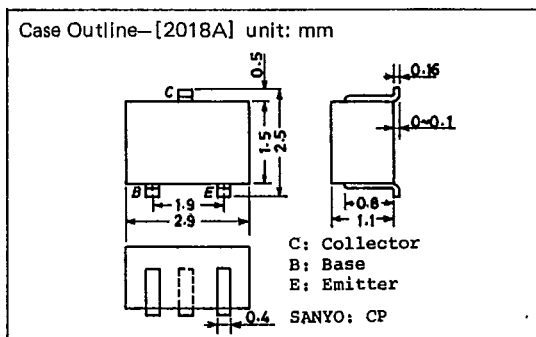

T-91-20

Case Outline—[2057] unit: mm

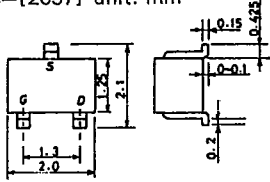

S: Source
G: Gate
D: Drain
SANYO: MCP

Case Outline—[2066] unit: mm

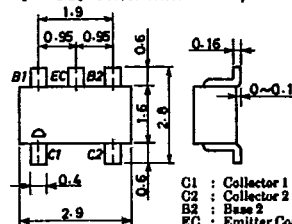

C1 : Collector 1
C2 : Collector 2
B2 : Base 2
EC : Emitter Common
B1 : Base 1
SANYO : CP6

Case Outline—[2058] unit: mm

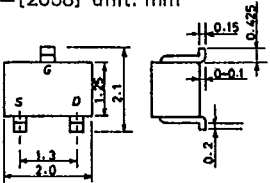

G: Gate
S: Source
D: Drain
SANYO: MCP

Case Outline—[2067] unit: mm

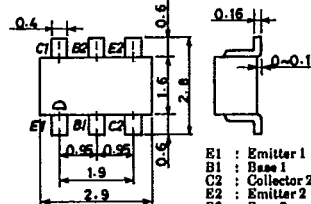

E1 : Emitter 1
B1 : Base 1
C2 : Collector 2
E2 : Emitter 2
B2 : Base 2
C1 : Collector 1
SANYO : CP6

Case Outline—[2059] unit: mm

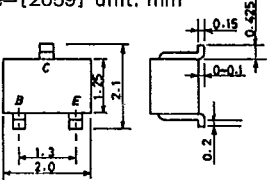

B: Base
C: Collector
E: Emitter
SANYO: MCP

Case Outline—[2068] unit: mm

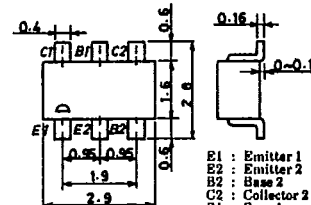

B1 : Emitter 1
E2 : Emitter 2
B2 : Base 2
C2 : Collector 2
B1 : Base 1
C1 : Collector 1
SANYO : CP6

Case Outline—[2062] unit: mm

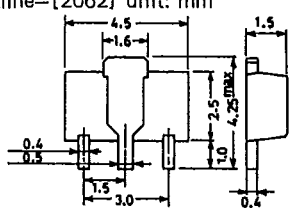

S: Source
D: Drain
G: Gate
SANYO: PCP

Case Outline—[2069] unit: mm

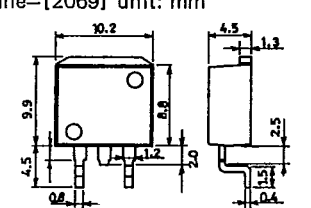

B: Base
C: Collector
E: Emitter
SANYO: SMP

Case Outline—[2065] unit: mm

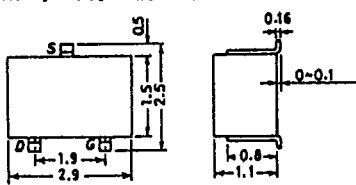

S: Source
D: Drain
G: Gate
SANYO: CP

Case Outline—[2070] unit: mm

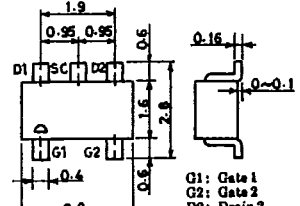

G1 : Gate 1
G2 : Gate 2
D2 : Drain 2
SC : Source Common
D1 : Drain 1
SANYO : CP6

T-9120

