



# STW20NC50

N-CHANNEL 500V - 0.22Ω - 18.4A TO-247

PowerMesh™II MOSFET

TYPE	V <sub>DSS</sub>	R <sub>DS(on)</sub>	I <sub>D</sub>
STW20NC50	500V	< 0.27Ω	18.4A

- TYPICAL R<sub>DS(on)</sub> = 0.22Ω
- EXTREMELY HIGH dv/dt CAPABILITY
- 100% AVALANCHE TESTED
- NEW HIGH VOLTAGE BENCHMARK
- GATE CHARGE MINIMIZED

### DESCRIPTION

The PowerMESH™II is the evolution of the first generation of MESH OVERLAY™. The layout refinements introduced greatly improve the Ron\*area figure of merit while keeping the device at the leading edge for what concerns switching speed, gate charge and ruggedness.

### APPLICATIONS

- SWITCH MODE LOW POWER SUPPLIES (SMPS)
- HIGH CURRENT, HIGH SPEED SWITCHING
- DC-AC CONVERTERS FOR WELDING EQUIPMENT AND UNINTERRUPTIBLE POWER SUPPLIES AND MOTOR DRIVES

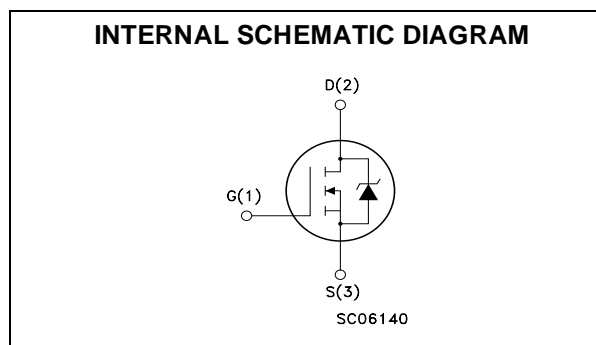
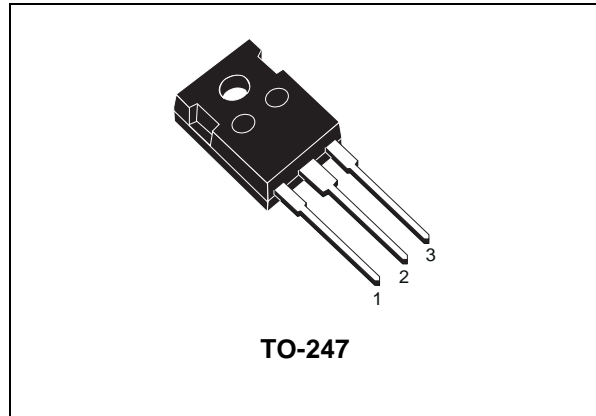

### ABSOLUTE MAXIMUM RATINGS

Symbol	Parameter	Value	Unit
V <sub>DS</sub>	Drain-source Voltage (V <sub>GS</sub> = 0)	500	V
V <sub>DGR</sub>	Drain-gate Voltage (R <sub>GS</sub> = 20 kΩ)	500	V
V <sub>GS</sub>	Gate- source Voltage	±30	V
I <sub>D</sub>	Drain Current (continuous) at T <sub>C</sub> = 25°C	18.4	A
I <sub>D</sub>	Drain Current (continuous) at T <sub>C</sub> = 100°C	11.6	A
I <sub>DM</sub> (●)	Drain Current (pulsed)	73.6	A
P <sub>TOT</sub>	Total Dissipation at T <sub>C</sub> = 25°C	220	W
	Derating Factor	1.75	W/°C
dv/dt(1)	Peak Diode Recovery voltage slope	2	V/ns
T <sub>stg</sub>	Storage Temperature	-65 to 150	°C
T <sub>j</sub>	Max. Operating Junction Temperature	150	°C

(●)Pulse width limited by safe operating area

(1)I<sub>SD</sub> ≤ 18.4A, di/dt ≤ 100A/μs, V<sub>DD</sub> ≤ V<sub>(BR)DSS</sub>, T<sub>j</sub> ≤ T<sub>JMAX</sub>.

## STW20NC50

### THERMAL DATA

Rthj-case	Thermal Resistance Junction-case Max	0.57	°C/W
Rthj-amb	Thermal Resistance Junction-ambient Max	30	°C/W
Rthc-sink	Thermal Resistance Case-sink Typ	0.1	°C/W
T <sub>l</sub>	Maximum Lead Temperature For Soldering Purpose	300	°C

### AVALANCHE CHARACTERISTICS

Symbol	Parameter	Max Value	Unit
I <sub>AR</sub>	Avalanche Current, Repetitive or Not-Repetitive (pulse width limited by T <sub>j</sub> max)	20	A
E <sub>AS</sub>	Single Pulse Avalanche Energy (starting T <sub>j</sub> = 25 °C, I <sub>D</sub> = I <sub>AR</sub> , V <sub>DD</sub> = 50 V)	960	mJ

### ELECTRICAL CHARACTERISTICS (TCASE = 25 °C UNLESS OTHERWISE SPECIFIED) OFF

Symbol	Parameter	Test Conditions	Min.	Typ.	Max.	Unit
V <sub>(BR)DSS</sub>	Drain-source Breakdown Voltage	I <sub>D</sub> = 250 μA, V <sub>GS</sub> = 0	500			V
I <sub>DSS</sub>	Zero Gate Voltage Drain Current (V <sub>GS</sub> = 0)	V <sub>DS</sub> = Max Rating V <sub>DS</sub> = Max Rating, T <sub>C</sub> = 125 °C			1 50	μA μA
I <sub>GSS</sub>	Gate-body Leakage Current (V <sub>DS</sub> = 0)	V <sub>GS</sub> = ±30V			±100	nA

### ON (1)

Symbol	Parameter	Test Conditions	Min.	Typ.	Max.	Unit
V <sub>GS(th)</sub>	Gate Threshold Voltage	V <sub>DS</sub> = V <sub>GS</sub> , I <sub>D</sub> = 250μA	2	3	4	V
R <sub>DS(on)</sub>	Static Drain-source On Resistance	V <sub>GS</sub> = 10V, I <sub>D</sub> = 9 A		0.22	0.27	Ω
I <sub>D(on)</sub>	On State Drain Current	V <sub>DS</sub> > I <sub>D(on)</sub> × R <sub>DS(on)max</sub> , V <sub>GS</sub> = 10V	18.4			A

### DYNAMIC

Symbol	Parameter	Test Conditions	Min.	Typ.	Max.	Unit
g <sub>fs</sub> (1)	Forward Transconductance	V <sub>DS</sub> > I <sub>D(on)</sub> × R <sub>DS(on)max</sub> , I <sub>D</sub> = 9A		18		S
C <sub>iss</sub>	Input Capacitance	V <sub>DS</sub> = 25V, f = 1 MHz, V <sub>GS</sub> = 0		2980		pF
C <sub>oss</sub>	Output Capacitance			410		pF
C <sub>rss</sub>	Reverse Transfer Capacitance			58		pF

**ELECTRICAL CHARACTERISTICS (CONTINUED)**

**SWITCHING ON**

Symbol	Parameter	Test Conditions	Min.	Typ.	Max.	Unit
$t_{d(on)}$	Turn-on Delay Time	$V_{DD} = 250V, I_D = 10A$ $R_G = 4.7\Omega, V_{GS} = 10V$ (see test circuit, Figure 3)		29		ns
$t_r$	Rise Time			21		ns
$Q_g$	Total Gate Charge	$V_{DD} = 400V, I_D = 20A,$ $V_{GS} = 10V$		95	128	nC
$Q_{gs}$	Gate-Source Charge			14.7		nC
$Q_{gd}$	Gate-Drain Charge			41.7		nC

**SWITCHING OFF**

Symbol	Parameter	Test Conditions	Min.	Typ.	Max.	Unit
$t_{r(Voff)}$	Off-voltage Rise Time	$V_{DD} = 400V, I_D = 20A,$ $R_G = 4.7\Omega, V_{GS} = 10V$ (see test circuit, Figure 5)		20		ns
$t_f$	Fall Time			21		ns
$t_c$	Cross-over Time			58		ns

**SOURCE DRAIN DIODE**

Symbol	Parameter	Test Conditions	Min.	Typ.	Max.	Unit
$I_{SD}$	Source-drain Current				18.4	A
$I_{SDM(2)}$	Source-drain Current (pulsed)				73.6	A
$V_{SD(1)}$	Forward On Voltage	$I_{SD} = 18.4A, V_{GS} = 0$			1.6	V
$t_{rr}$	Reverse Recovery Time	$I_{SD} = 20A, di/dt = 100A/\mu s,$ $V_{DD} = 100V, T_j = 150^\circ C$ (see test circuit, Figure 5)		480		ns
$Q_{rr}$	Reverse Recovery Charge			5		$\mu C$
$I_{RRM}$	Reverse Recovery Current			21		A

Note: 1. Pulsed: Pulse duration = 300  $\mu s$ , duty cycle 1.5 %.  
2. Pulse width limited by safe operating area.

**Safe Operating Area**

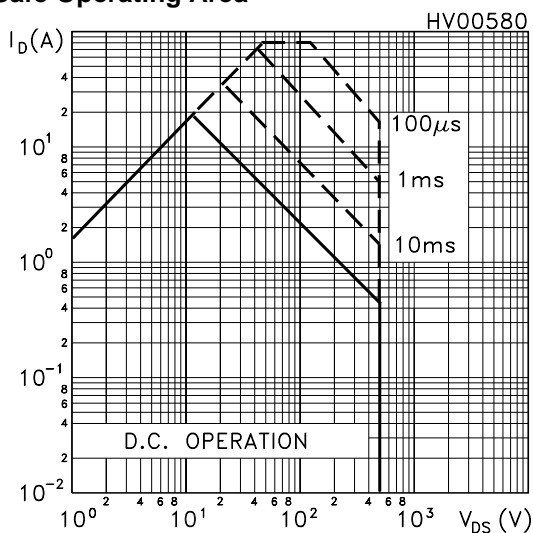

**Thermal Impedance**

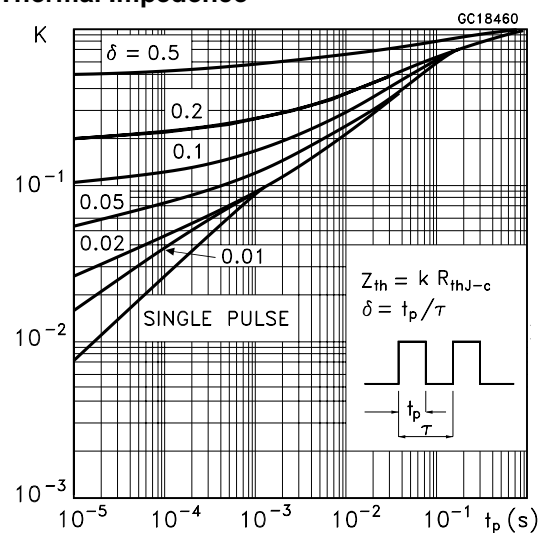

Output Characteristics

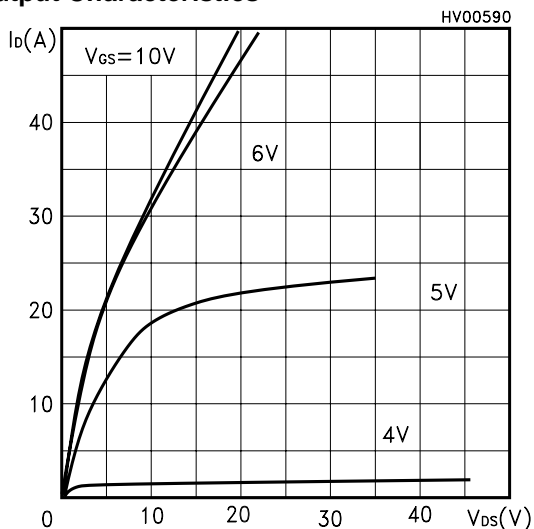

Transfer Characteristics

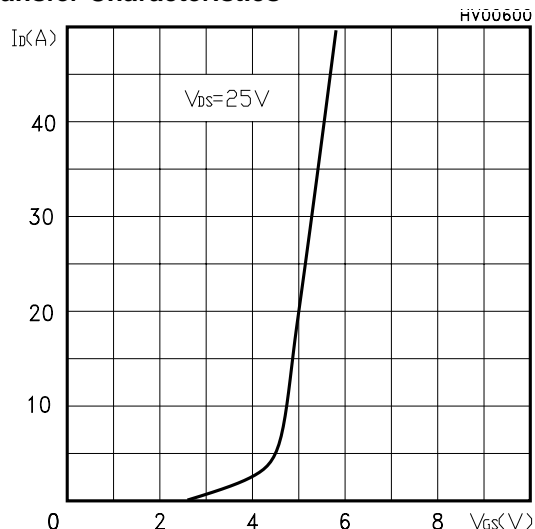

Transconductance

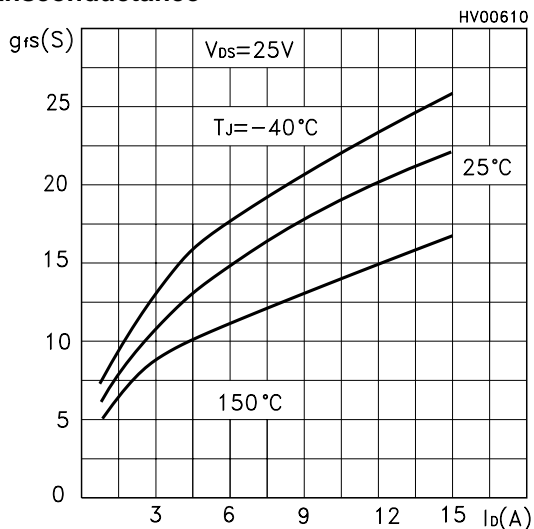

Static Drain-source On Resistance

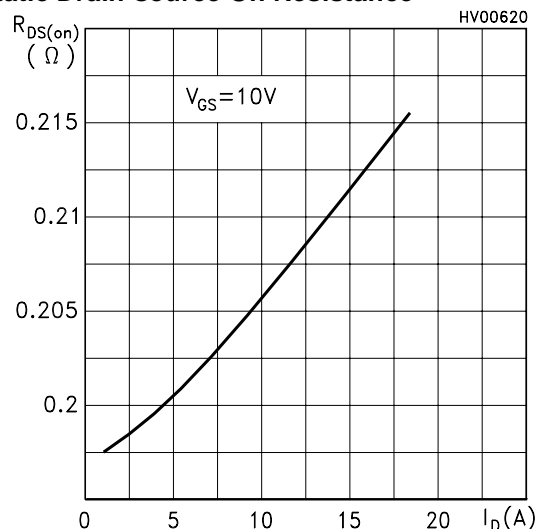

Gate Charge vs Gate-source Voltage

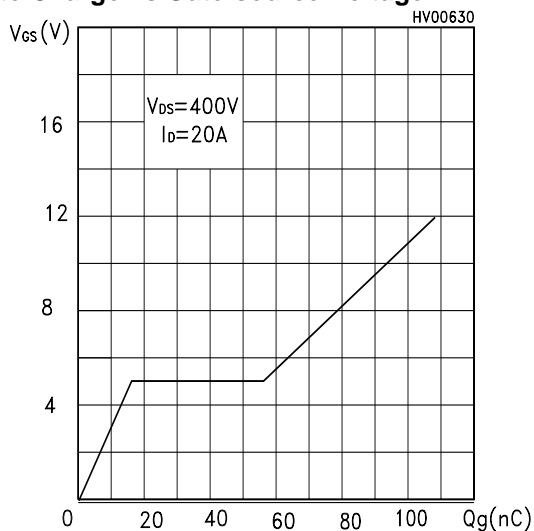

Capacitance Variations

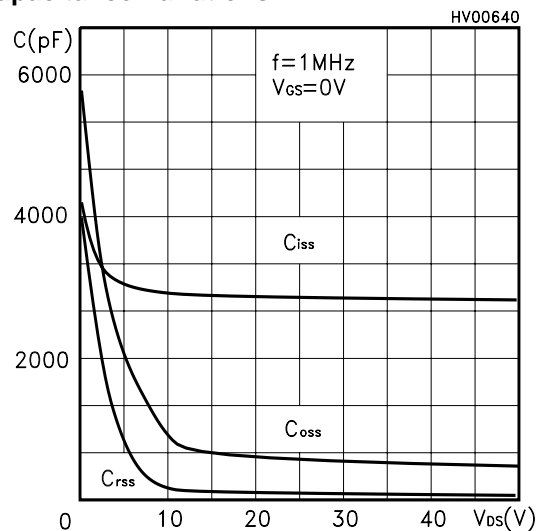

Normalized Gate Thershold Voltage vs Temp.

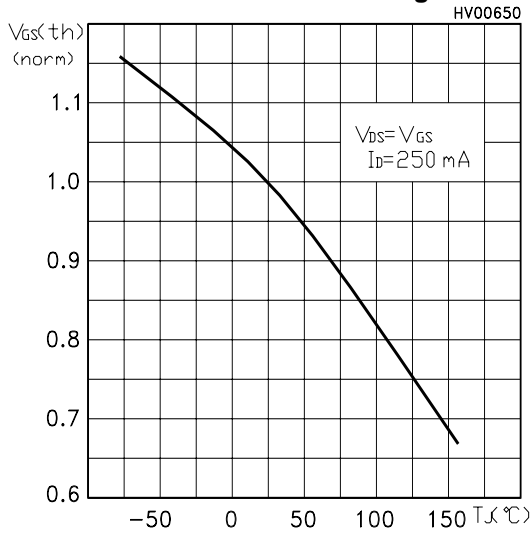

Normalized On Resistance vs Temperature

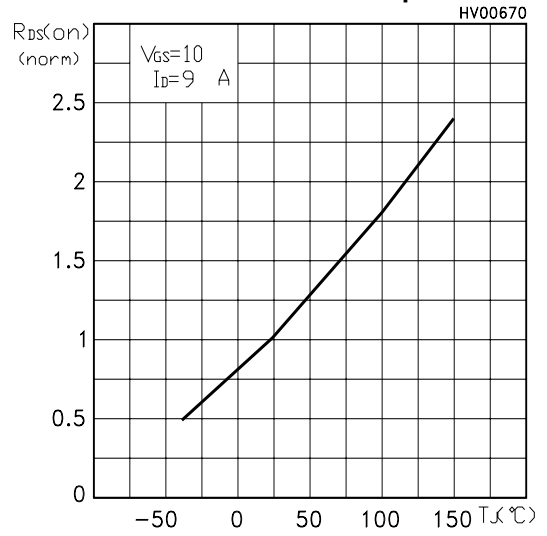

Source-drain Diode Forward Characteristics

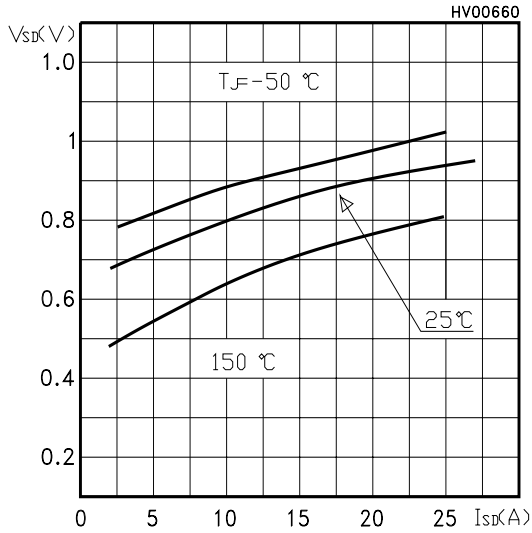

Fig. 1: Unclamped Inductive Load Test Circuit



Fig. 2: Unclamped Inductive Waveform



Fig. 3: Switching Times Test Circuit For Resistive Load



Fig. 4: Gate Charge test Circuit

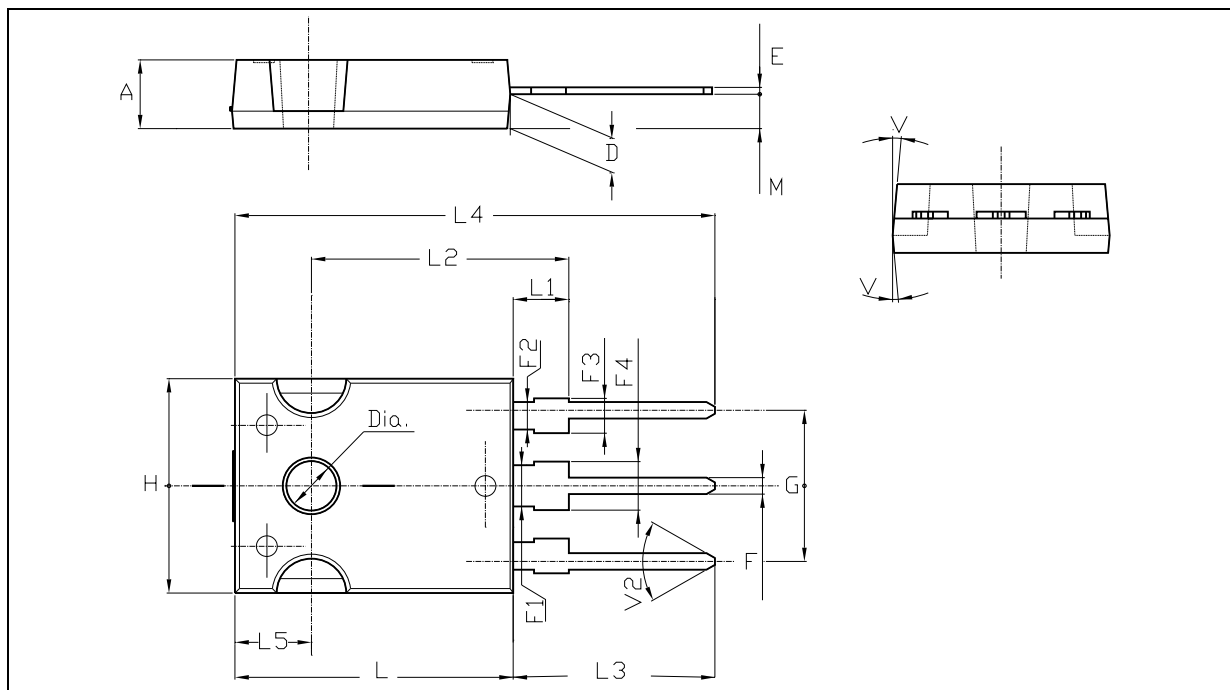

Fig. 5: Test Circuit For Inductive Load Switching And Diode Recovery Times



## TO-247 MECHANICAL DATA

DIM.	mm.			inch		
	MIN.	TYP	MAX.	MIN.	TYP.	MAX.
A	4.85		5.15	0.19		0.20
D	2.20		2.60	0.08		0.10
E	0.40		0.80	0.015		0.03
F	1		1.40	0.04		0.05
F1		3			0.11	
F2		2			0.07	
F3	2		2.40	0.07		0.09
F4	3		3.40	0.11		0.13
G		10.90			0.43	
H	15.45		15.75	0.60		0.62
L	19.85		20.15	0.78		0.79
L1	3.70		4.30	0.14		0.17
L2		18.50			0.72	
L3	14.20		14.80	0.56		0.58
L4		34.60			1.36	
L5		5.50			0.21	
M	2		3	0.07		0.11
V		5°			5°	
V2		60°			60°	
Dia	3.55		3.65	0.14		0.143



Information furnished is believed to be accurate and reliable. However, STMicroelectronics assumes no responsibility for the consequences of use of such information nor for any infringement of patents or other rights of third parties which may result from its use. No license is granted by implication or otherwise under any patent or patent rights of STMicroelectronics. Specification mentioned in this publication are subject to change without notice. This publication supersedes and replaces all information previously supplied. STMicroelectronics products are not authorized for use as critical components in life support devices or systems without express written approval of STMicroelectronics.

The ST logo is a trademark of STMicroelectronics

© 2000 STMicroelectronics – Printed in Italy – All Rights Reserved  
STMicroelectronics GROUP OF COMPANIES

Australia - Brazil - China - Finland - France - Germany - Hong Kong - India - Italy - Japan - Malaysia - Malta - Morocco -  
Singapore - Spain - Sweden - Switzerland - United Kingdom - U.S.A.

<http://www.st.com>